

Reception Teacher's Handbook

Phase Two Week 1

Resource Pack

Contents

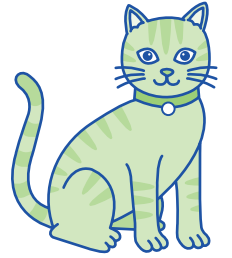

Mnemonic for s	1
Mnemonic for a	2
Mnemonic for t	3
Mnemonic for p	4
Phase One Initial sounds sets picture cards	5
Phase One Oral blending and segmenting picture cards ...	10
Phase One Tog posting box	15

Mnemonic for s



Mnemonic for a

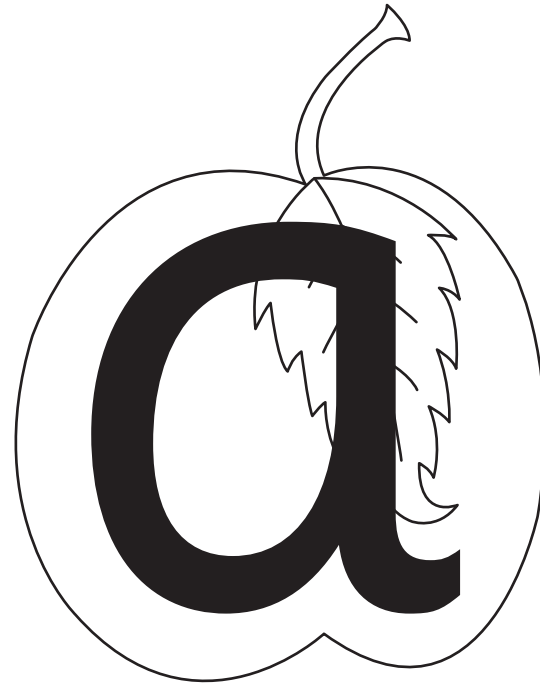

Mnemonic for **t**

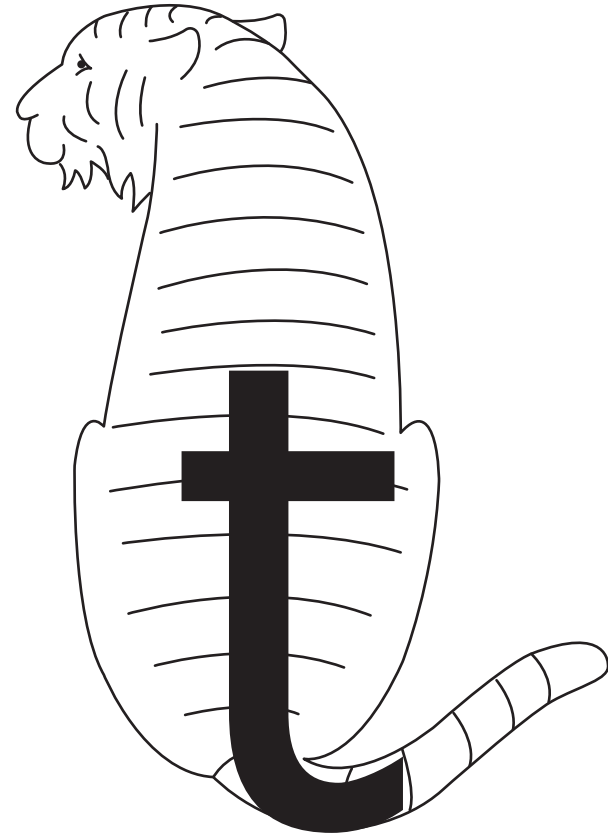
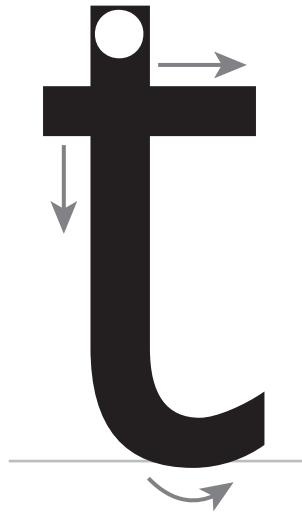

Mnemonic for **p**

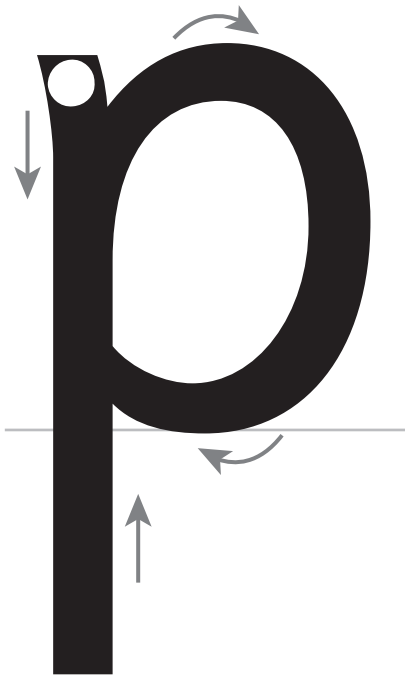

Phase One Initial sounds sets picture cards

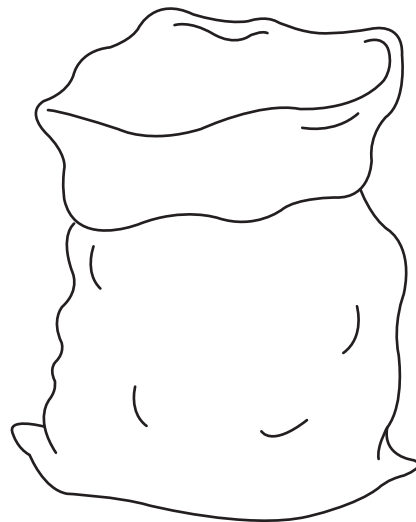
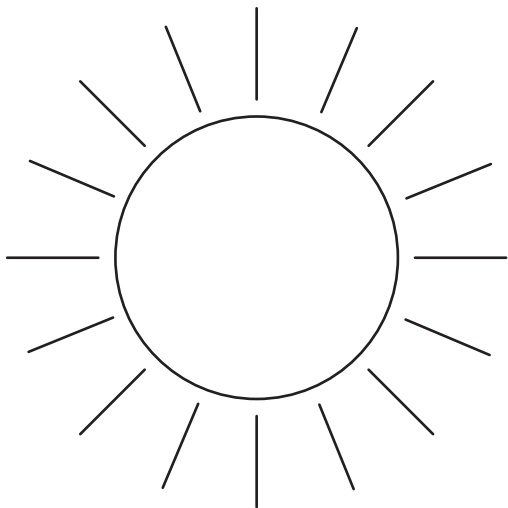
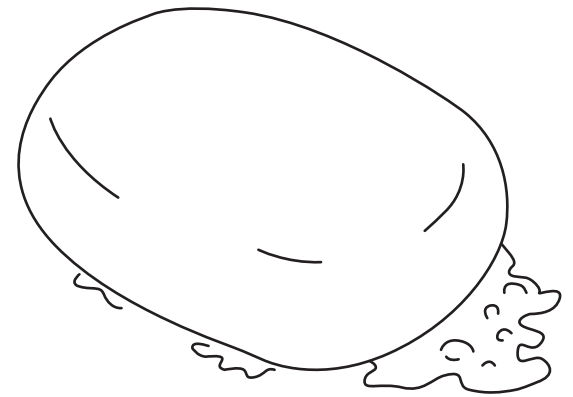
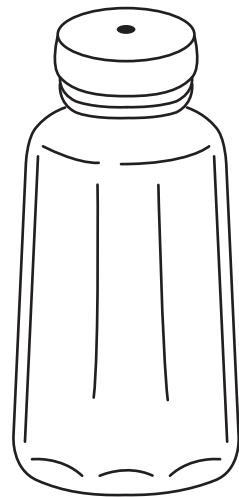
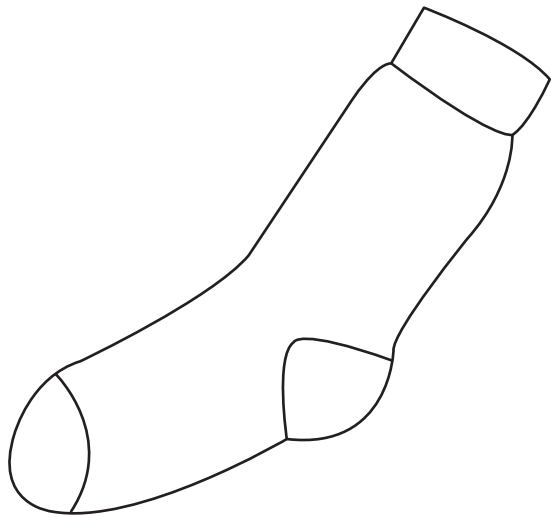

Phase One Initial sounds sets picture cards continued

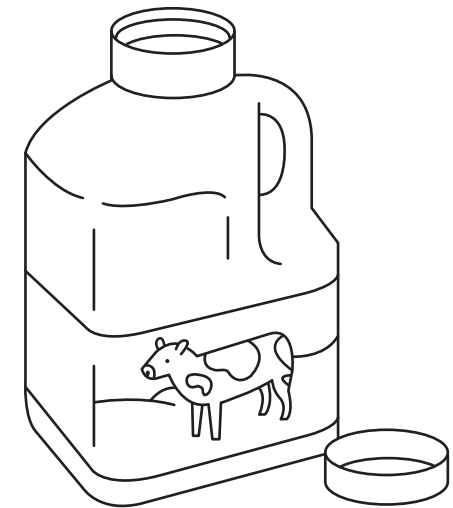
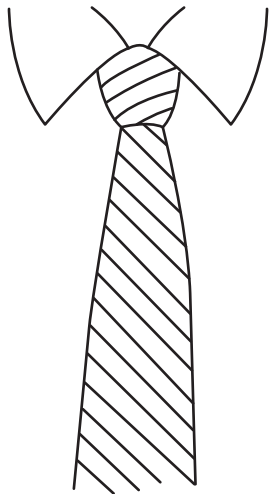
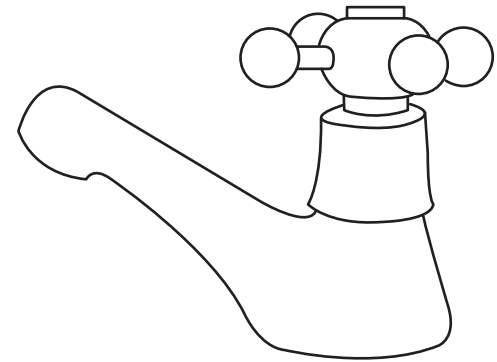
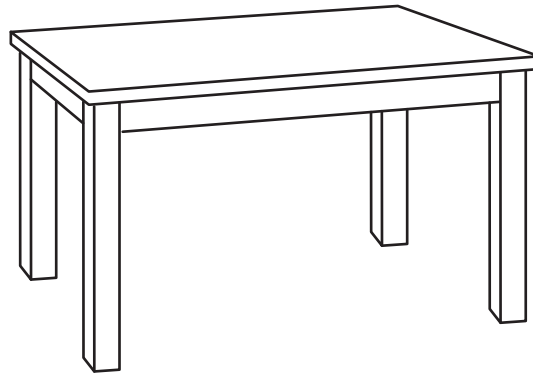
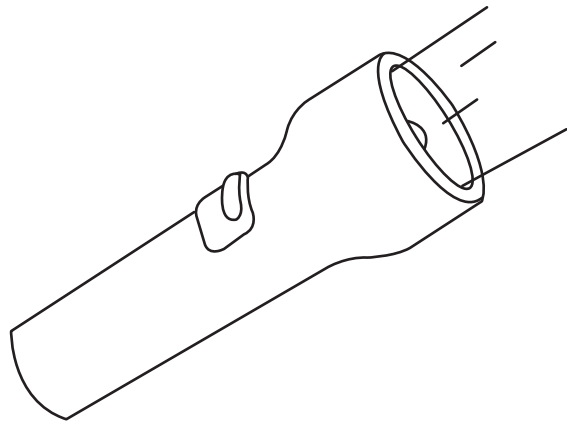

Phase One Initial sounds sets picture cards continued

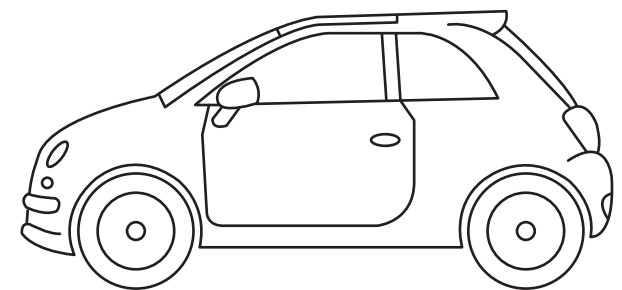
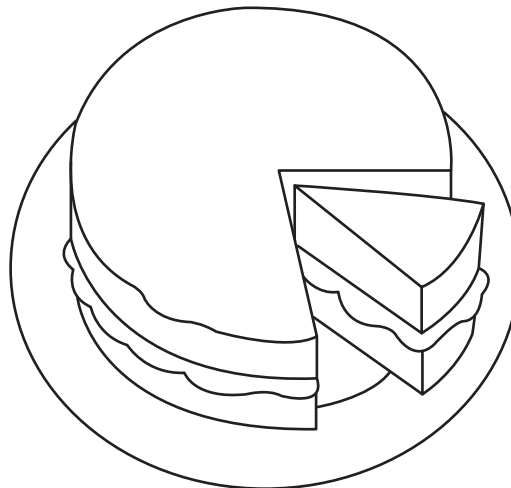
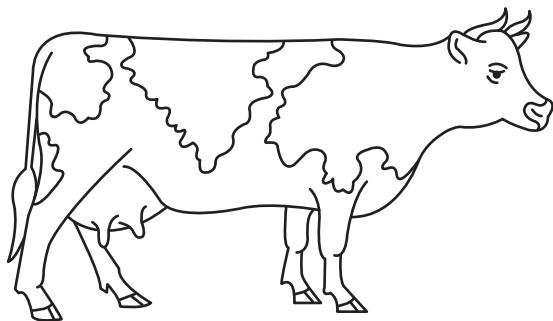
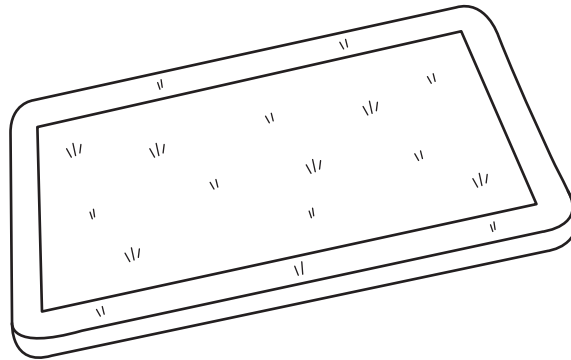
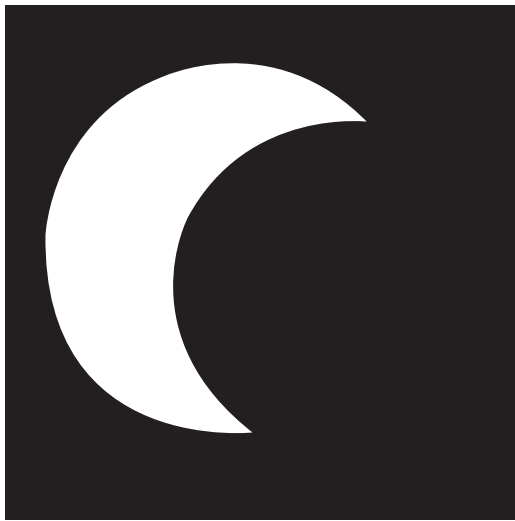

Phase One Initial sounds sets picture cards continued

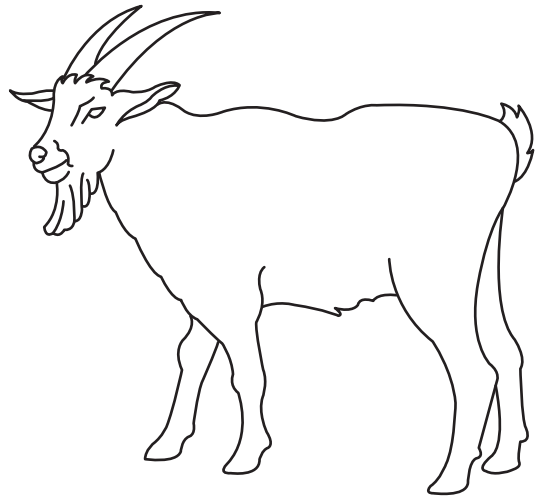
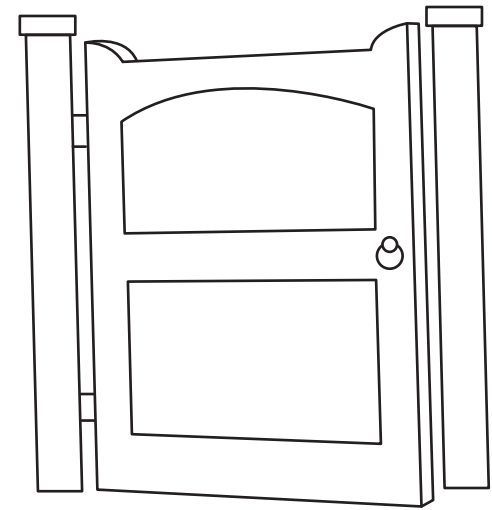
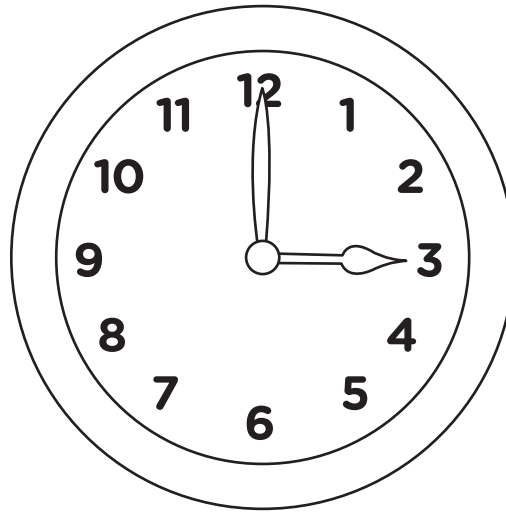
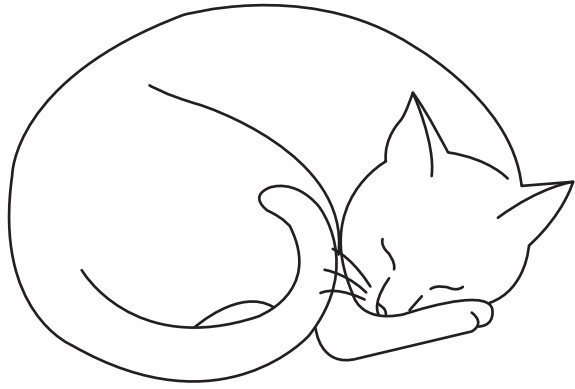

Phase One Initial sounds sets picture cards continued

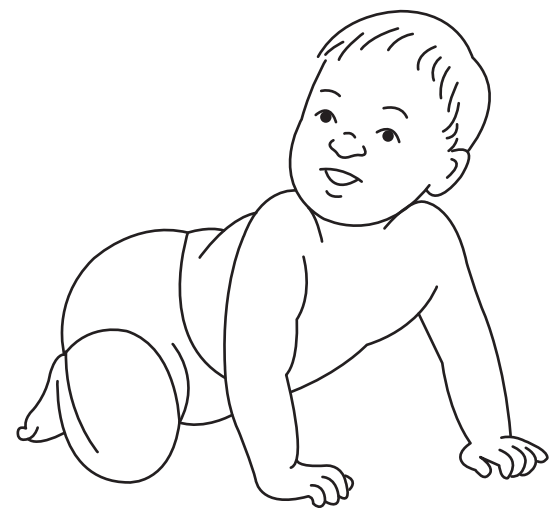
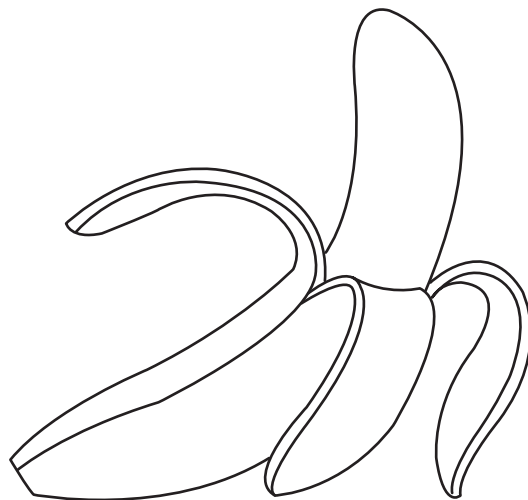
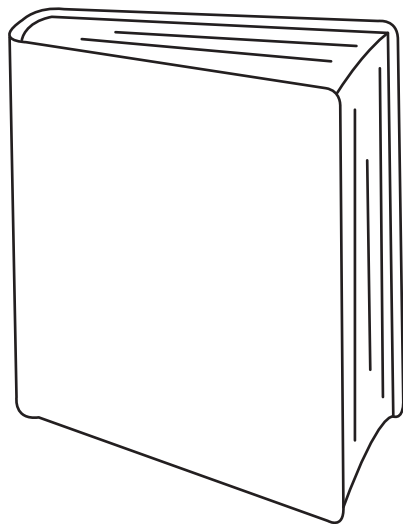
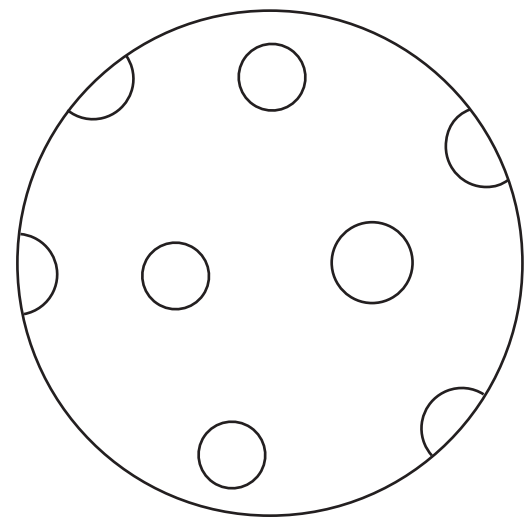
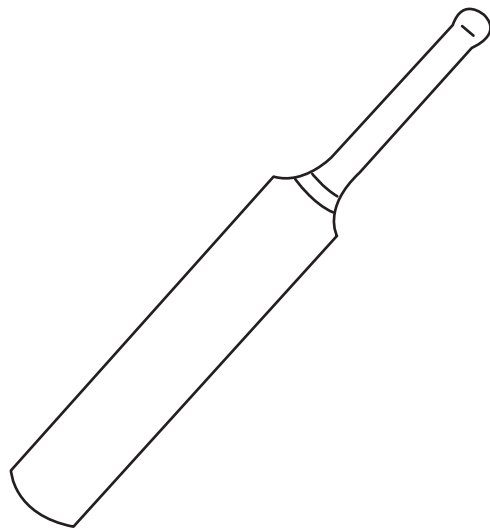
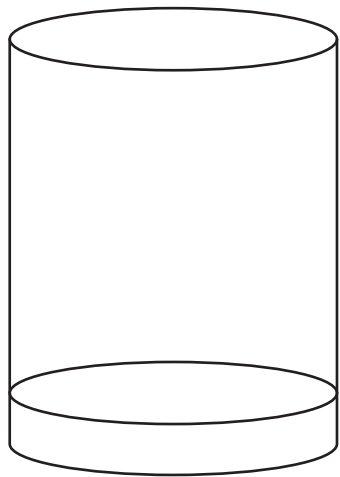

Phase One Oral blending and segmenting picture cards

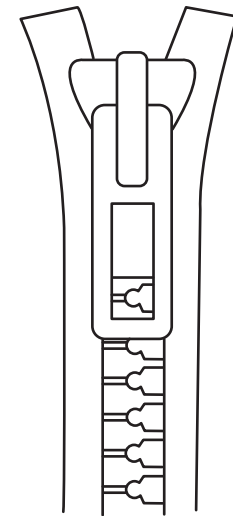
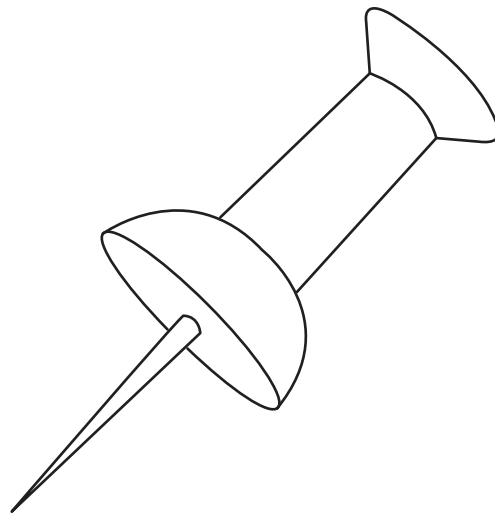
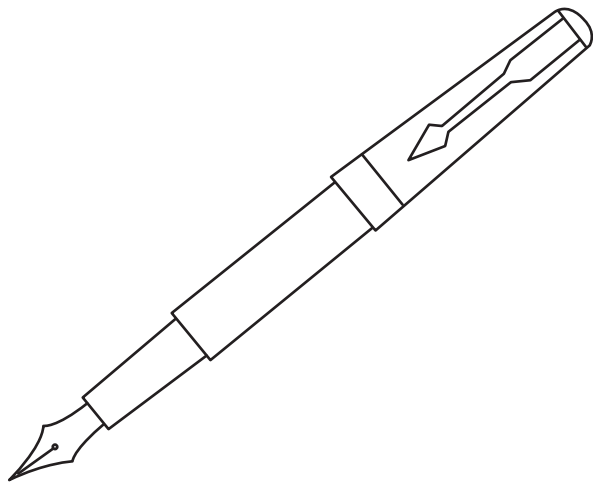
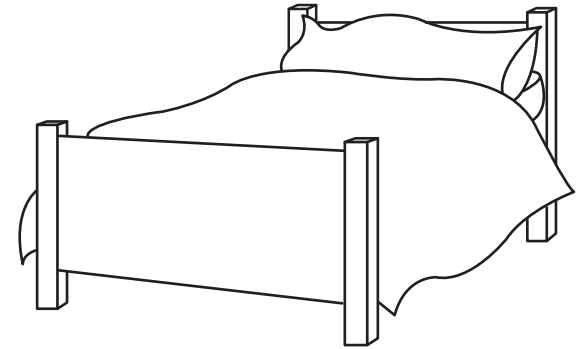
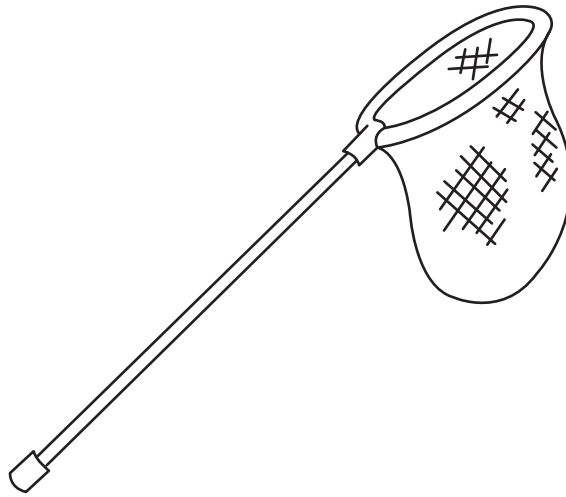
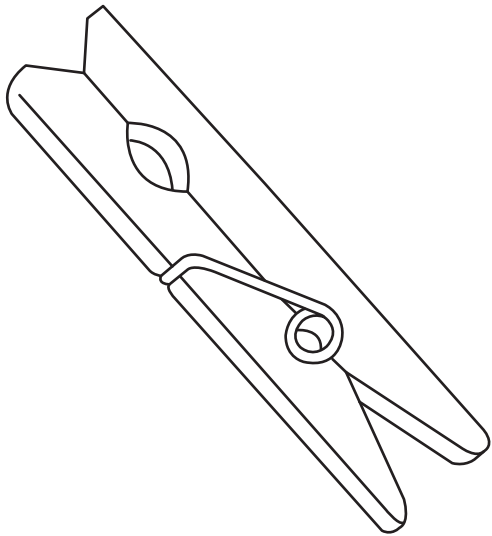

Phase One Oral blending and segmenting picture cards continued

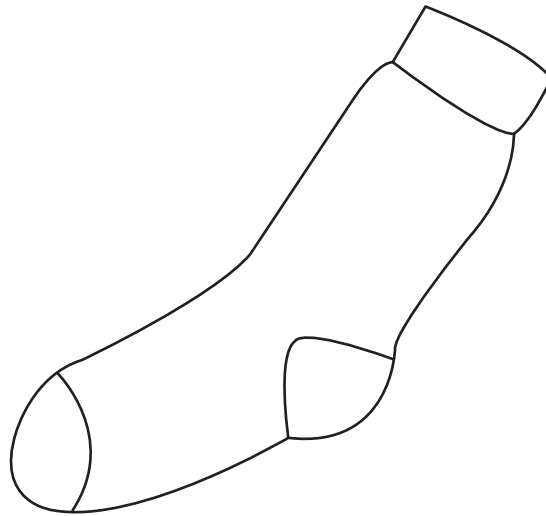
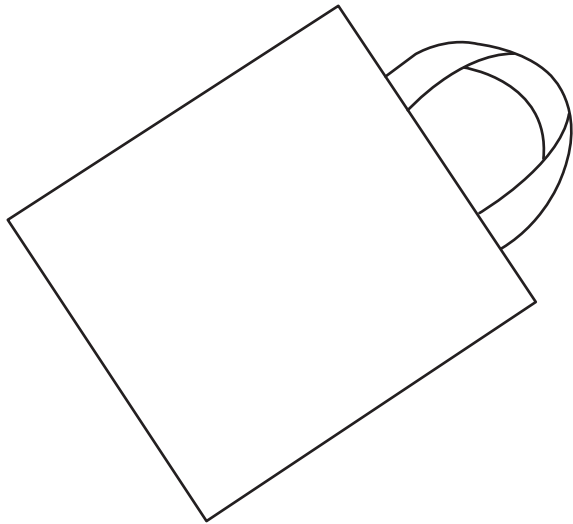
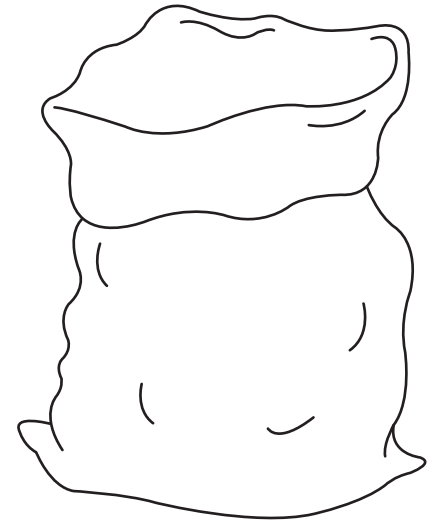
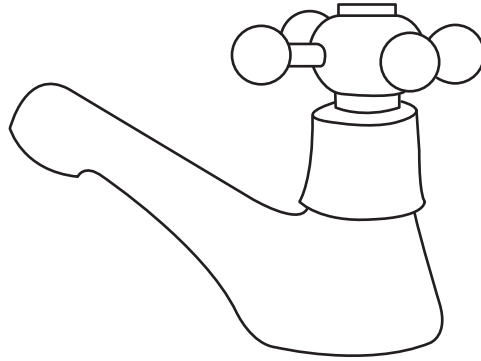
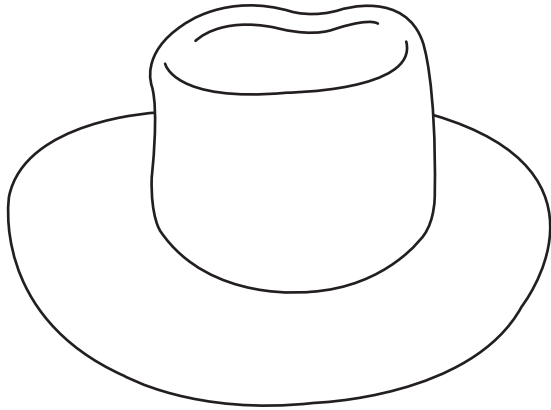

Phase One Oral blending and segmenting picture cards continued

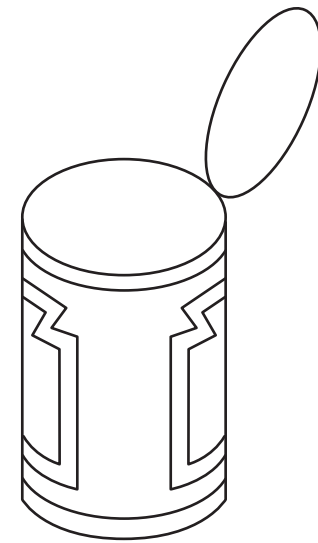
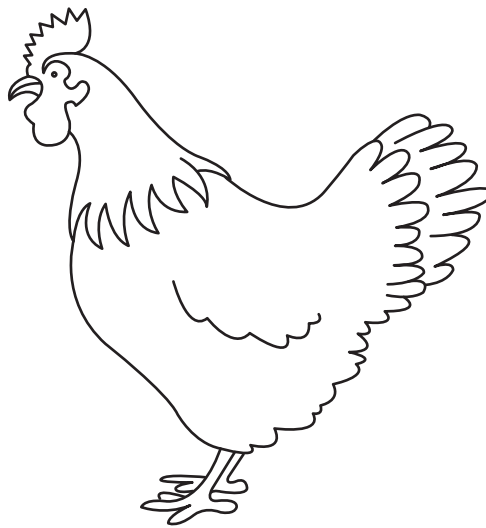
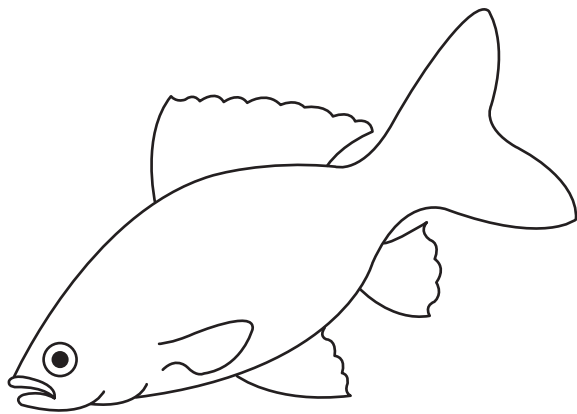
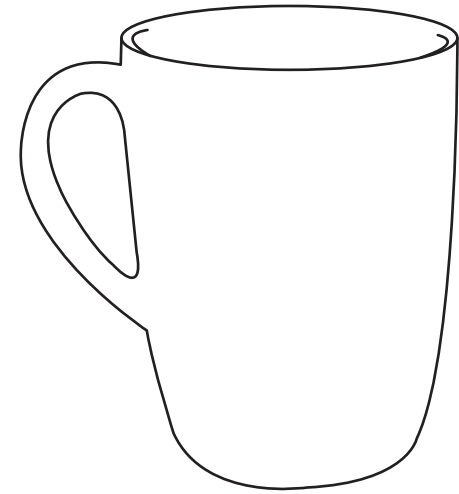
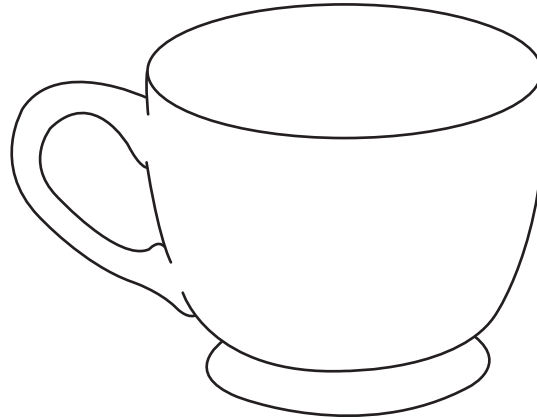
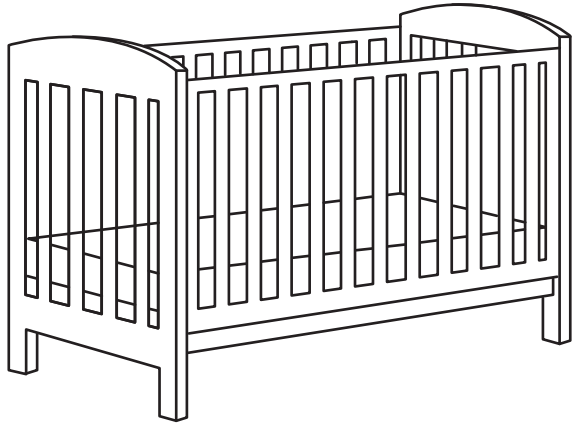

Phase One Oral blending and segmenting picture cards continued

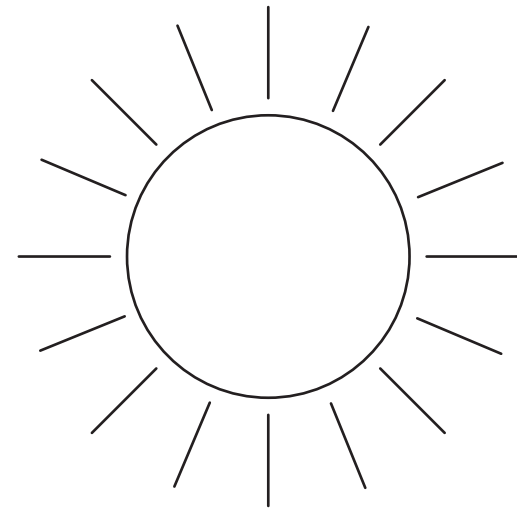
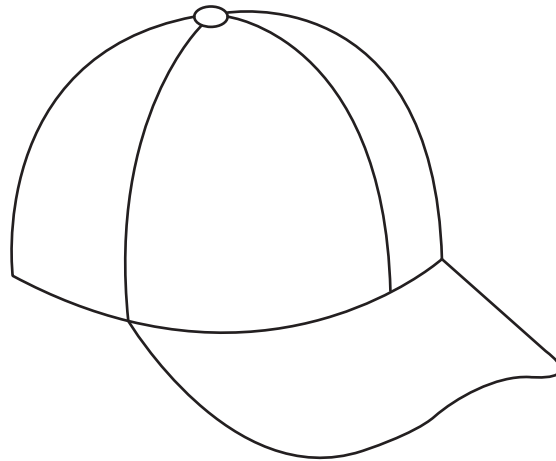
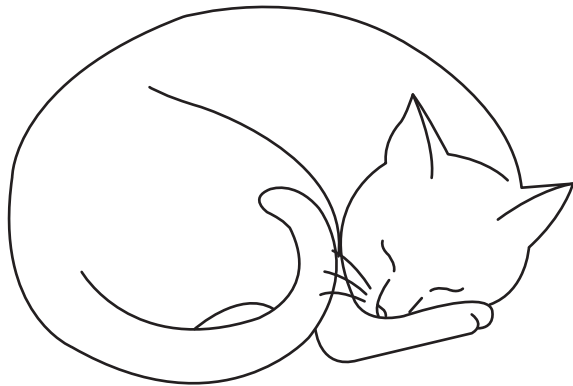
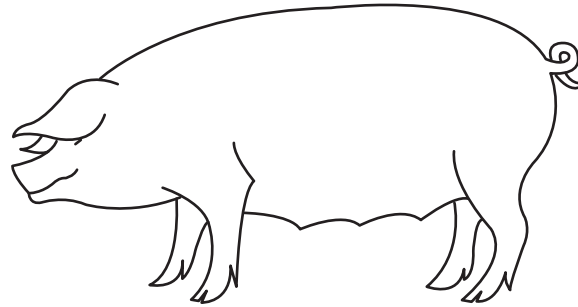

Phase One Oral blending and segmenting picture cards continued

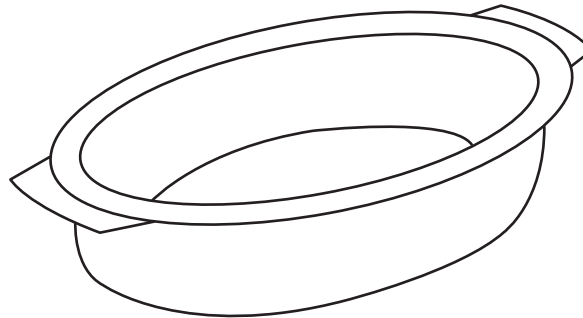
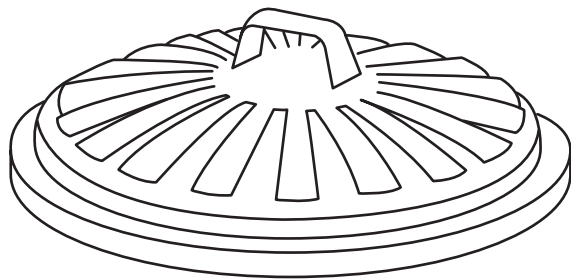
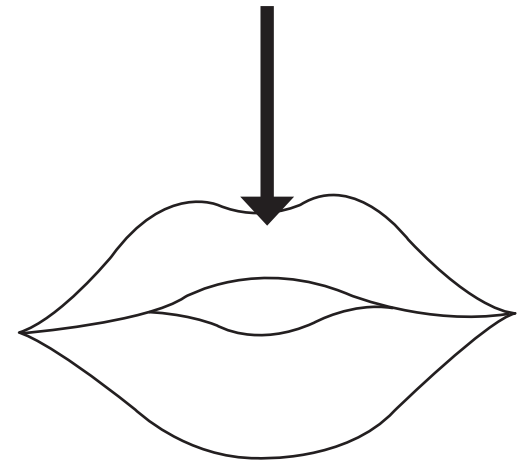
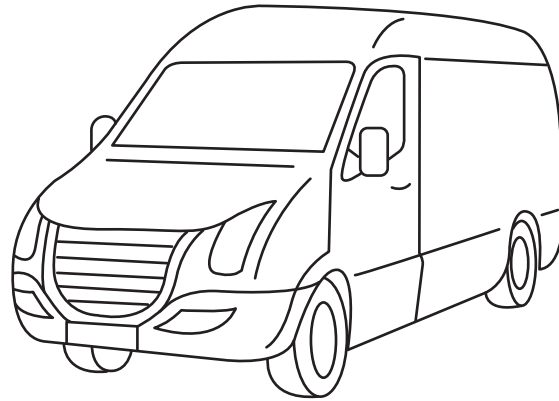
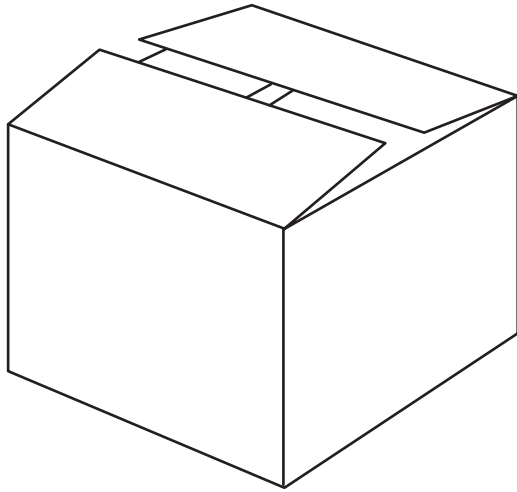

Phase One Tog posting box

Stick the template onto a cardboard box and cut out the mouth, so the children can 'post' word and grapheme cards through. The **Tog posting box** can also be used in a range of blending and segmenting activities, as described in the lesson plans.

